

# Sensigas<sup>®</sup>

## Gas Detectors

### Carbon Dioxide (CO<sub>2</sub>)

ATEX II 2G Ex d IIC T6<sup>(1)</sup> Gb certified  
MED/3.54 (IEC 60092-504) certified

## URD21IE



10÷28Vdc Power Supply.

Nondispersive infrared (NDIR) sensor designed for the detection of Carbon Dioxide (CO<sub>2</sub>).

Up to three intervention thresholds.

Automatic counting of the lifetime of the sensors.

LED on the sensor body to indicate the operating status and display option.

**Use** URD21IE Detectors are used to detect the presence of Carbon Dioxide (CO<sub>2</sub>), in areas classified as Zone 1.

Detection of Carbon Dioxide emissions or emissions in industrial environments, hospitals, fermentation plants, greenhouses, stables and, more generally, where carbon dioxide is stored, generated or produced.

URD21IE Detectors are designed for stand-alone operation with 4 ÷ 20mA output and, optionally, with n. 4 relay outputs with voltage free changeover contacts respectively for:

Pre-Alarm, 1<sup>st</sup> Alarm Threshold, 2<sup>nd</sup> Alarm Threshold, Sensor fail.

**Operation** In case of Gas presence, the Detector compares the measured concentration value with the intervention thresholds set by activating the relays associated with them. The information of the measured concentration value is always present on the 4 ÷ 20mA output.

**Ordering** Simply indicate product code: please, refer to “available models”.

Available Models

**Code:** \* UR xx yy I E \*\*

- E = Explosion Proof Execution
- Sensing Element type:  
I = Non Dispersive Infrared (NDIR)
- “21” for Stand Alone detectors with 4...20 mA output  
“41” for Bus Based System EW40
- D = Carbon Dioxide (CO<sub>2</sub>)

\* Prefix to the name of the Detector: DR = Display with Relays; DN = Display without Relays;

\*\* Suffix to the name of the Detector: EXR = Extended temperature range -40...+70°C

## Technical Characteristics

Sensor type	Non Dispersive Infrared (NDIR)
Detected gas	Carbon Dioxide (CO <sub>2</sub> )
Power supply	10÷28Vdc
Maximum Power consumption	2,4W
(@ 28Vdc with d.c. 4÷20mA output)	(4W with UZR20.4)
Measuring range	0...20.000ppm <sup>(2)</sup> <sup>(3)</sup>
Precision	± 5% of Full Scale, ± 10% of reading
Repeatability	± 5% of Full Scale, ± 10% of reading
Measurement Resolution (Sensitivity)	20 ppm
Microprocessor Resolution	4096 points (12 bit A/D Converter)
Measuring digital processing	Kalman Filter and zero drift compensation
Watch dog	External, acting on the whole Safety Chain
Warm-up time	< 2m
Stabilization Time	< 2m
Response Time (Max)	< 20s (T50), < 60s (T90)
Average Sensor Life (in Air)	255 weeks
Output Logic 4...20mA:	
Proportional Logic (default)	- 4mA = 0 ppm - 20mA = 20.000 ppm
Threshold Logic (1 o 2 Threshold Application)	- 0mA = No Alarm - 10mA = 1 <sup>st</sup> Threshold Alarm - 20mA = 2 <sup>nd</sup> Threshold Alarm
Signal 4÷20mA reference setting	With jumpers (reference to negative or positive of power supply)
Load Resistance of 4...20mA output (with generator limited to 24mA)	minimum 0Ω @ 28Vdc Maximum 300Ω @ 10Vdc
Operation and storage conditions:	
Environment Temperature (°C)	-20 ÷ 50 or -40 ÷ 70 (Extended Range)
- Operating	-20 ÷ 70
- Storage	
Relative Humidity (%UR) without cond.	
- Operating	15 ÷ 90
- Storage	45 ÷ 75
Operating Pressure (KPa)	80 ÷ 120
Air Speed (m/s)	≤ 6
Optical Signalling	Red LED visible on the sensor body
Dimensions and Weight	See dedicated paragraph

MED Marking



0474 / xxxx (manufacturing year)  
CERTIFICATE n. MED327120CS

ATEX Marking



1370 II 2G Ex d IIC T6<sup>(1)</sup> Gb  
BVI 07 ATEX 0032 + EXT 03/19  
-20°C ≤ T<sub>A</sub> ≤ +50°C  
-40°C ≤ T<sub>A</sub> ≤ +70°C (Extended Range)

Note <sup>(1)</sup>: DR-URD21IE-EXR Detectors, i.e. equipped with a Display Board with Relay (prefix **DR-**), with an extended temperature range (suffix **-EXR**), have temperature class T5 instead of T6.

Note <sup>(2)</sup>: Measuring range 0...20.000ppm is the default one; other measuring ranges are available on request.

Nota <sup>(3)</sup>: When Detector detects a very high gradient of increasing concentration, and the full-scale value of 20% is exceeded, power is removed from the sensing element and the out-of-range (fault condition for overrange) is declared respectively with:

- the 4÷20mA output which is set at 22mA;
- fault relay output activated (relay energized or not depending on the selection made);
- the status LED visible from outside fixed on with an OFF flash of 0.5s every 5s display (if present), explicitly declares the need for a recalibration.

After such a condition occurs:

- make sure the area is free of explosive mixtures;
- turn off and turn on the detector to allow the sensing element to be powered and wait at least an hour to allow thermal stabilization.

Only entering the calibration procedure can bring the detector to exit the overrange fault state.

As with all other operational contexts:

- if the recalibration procedure is successful, it can bring the detector into normal operating status;
- if the recalibration procedure is not successful, the detector is simply declared faulty.

**Technical Characteristics  
(continue)**

**4 Relays SPDT Card UZR20.4<sup>(4)</sup>**

It is used to activate signals and/or external systems (light signals, sirens, ventilation systems, etc.).

NO or NC contacts available, selectable by jumpers.

N. 4 LEDs are present and associated with the status of each Relay and separate quick-connecting term. blocks

The state of the LEDs is directly associated with the status of the relative Relay: Relay X "On" => Led X "On".

Relay contact range:

Relay control logic:

Note <sup>(4)</sup>: not insertable if the Display Board **DR...** or **DN...** is present

50mA a 24Vac/dc, 100mA a 12Vac/dc

- Direct: Relay ON in the presence of an event
- Inverse: Relay ON in the absence of an event

**Display Board without Relay DN-DetName.**

**Display Board with Relay DR-DetName.**

Display Boards are in fact the Operator Interface on board the Detector for control, monitoring, calibration and calibration operations. They manage:

N. 4 Sensors for Magnetic Actuator used to give the operator commands;

N. 4 SPDT Relay (only for DR .. Board)

Each Relay is associated with a Led for the local Alarm or Sensor Fault signaling

The state of the Leds is associated directly to the status of the relative Relay: Relay X "On" => Led X "On"

N. 6 heating resistors for Extended Range Detectors

(suffix **-EXR** to the name of the detector)

**PhotoMOS Card UZS20..**

It is used to indicate the status of the detector through a resistive value presented at the terminals.

It is typically used in conjunction with modules that put on the LOOP peripheral fire alarms that have a behavior similar to that of smoke detectors.

<b>UZS20.E</b>	<u>Normal</u>	<u>Pre-AL</u>	<u>1<sup>st</sup> Th</u>	<u>2<sup>nd</sup> Th</u>	<u>Fail</u>
	22kΩ	10kΩ	2,2 kΩ	n.p.	Open

<b>UZS20.A</b>	<u>Normal</u>	<u>Pre-AL</u>	<u>1<sup>st</sup> Th</u>	<u>2<sup>nd</sup> Th</u>	<u>Fail</u>
	27kΩ	n.p.	10kΩ	n.p.	Open

<b>UZS20.S</b>	<u>Normal</u>	<u>Pre-AL</u>	<u>1<sup>st</sup> Th</u>	<u>2<sup>nd</sup> Th</u>	<u>Fail</u>
	2,2kΩ	n.p.	Close	n.p.	Open

**Card for Magnetic Actuator. UZMAG**

The card, for **UCM** magnetic actuator, is intended to allow the detector to be calibrated without opening the enclosure which would require the declassification of the area at risk of explosion in which the detector is used. It connects to the detector through the same connector as the display board and is therefore an alternative to it.

**Verification and Calibration Kit TUS40..**

Service and Maintenance Terminal with Interface Board **UIC20.**

See Chapter for Commissioning and Start-up.

**Replacement Sensor Body NRXX-Y-ZZZ**

Sensor body complete with relevant signal conditioning card.

See dedicate price list.

## Sensor Lifetime

Sensor average lifetime (see technical characteristics) is referred to a typical usage in a pollution-free environment. Presence of a high concentration of pollutants can shorten the lifetime of the sensing element.

*Do not use pure gas or the lighter directly on the Sensor which could be irreparably damaged.*

**CAUTION:** consider that in particularly polluted environments or with vapours of flammable substances (in particular solvents), the useful life of the sensor can be considerably reduced. Some Substances cause a permanent reduction in sensitivity, preventing the Sensor from coming into contact with Silicone Vapours (present in Paints and Sealants), Lead Tetraethyl or Esters Phosphates. Other substances cause a temporary loss of Sensitivity, these "Inhibitors" are Halogens, Hydrogen Sulphate, Chlorine, Chlorinated Hydrocarbons. In the latter case, after a short time in Clean Air, the Sensor resumes its normal operation.

Once the detection system starts up, it has to be supplied with energy during all the lifetime of its sensors.

Seasonal use is not recommended.

## Mechanical Installation

For Sensors installation, follow the rules as in the diagram:

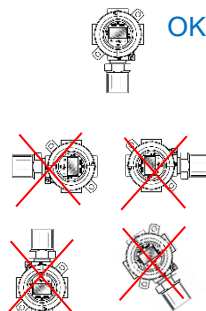

Carbon Dioxide density, at ambient temperature and pressure, is about one and a half times that of air; it therefore tends to stratify on the bottom of closed and unventilated environments.

Sensor must therefore be installed at a distance of about 30 cm from the floor of the room, or slightly higher.

Positioning of the sensors must take into account not only the aforementioned general rules, but also the following installation rules.

Sensors must be installed:

1. Near possible gas leak points;
2. At least 1.5m from heat sources and ventilation openings;
3. Never in poorly ventilated areas where gas pockets may occur;
4. Away from obstacles to the natural movement of the gas;
5. Far from appliances that throughout their normal working can have functional gas leakage;
6. in environments where atmospheric conditions are between  $-20^{\circ}\text{C}$  and  $50^{\circ}\text{C}$  and relative humidity lower than 90% without condensation;
7. The assembly and disassembly of the sensors must be carried out when the appliance is not live.

The number of sensors to be installed in an environment is proportional to its surface, its height and conformation, as well as the relative density of the gas.

The installation must also take into account:

- The geometry of the structures (beams, false ceilings, wells, etc.)
- Mechanical and liquid protection
- Poisoning protection
- Accessibility for appliance maintenance.

The installation of the detectors must take place as late as possible to avoid damage, but in time to adequately protect the environment for which they are intended

## Special Advise

**CAUTION: Safety is guaranteed only if cover is properly tightened and locked.**

- Tighten the cover in a clockwise direction, then verify that between case and cover there are no more than 0,5mm: it assures a perfect closing. Remember to tighten the grain placed on the cover.
- Respect the warning "DO NOT OPEN WHEN ENERGIZED" written on the cover, or declass the area before opening the cover.

**Electrical Installation**

**CAUTION:** Make the area safe and make sure that the device power supply is off before cabling and configuration operations.

Install the sensor in compliance with EN 60079-14.  
ATEX certified 1" NPT cable glands are used for cable entry, in compliance with standards EN 60079-0 and EN 60079-1 (Ex d protection mode).  
Ground the sensor using the internal grounding system.

**Terminal Block and Electrical Connections**

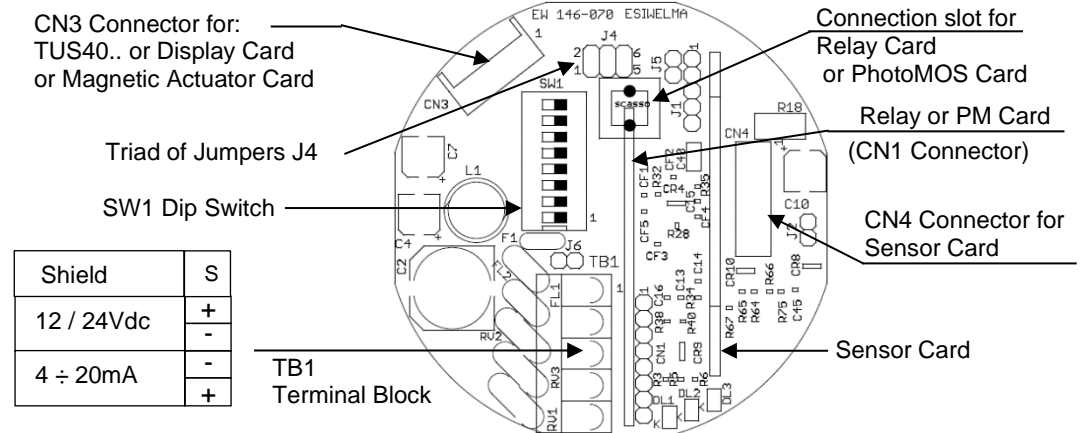

**Cabling:**

Depending on the connecting distance, use at least 3-core cable, min. diameter 0.75mm<sup>2</sup> up to 100m, 1mm<sup>2</sup> up to 200m, 1.5mm<sup>2</sup> up to 500m.  
Use shielded cable where there is a risk of electromagnetic interference.  
If a relay card is used, use multi-core cable suitable for the number of connections.  
Make sure that the cable sheath is no larger than the diameter of the cable gland.

**Configuration:**

The Sensor is supplied with base settings shown as default into Technical Characteristics Chapter.  
To change such settings, switch off the power supply, input the new settings by means the triad of jumpers **J4** or on Dip Switch **SW1** as in figure then power-up again; in particular:

**4÷20mA Output reference selection:**

The sensor is basically set to have the negative of the power supply signal as a reference for the 4÷20mA signal; to change this setting it is necessary to move the set of jumpers referred to in the **J4** screen printing position as shown in the figure:

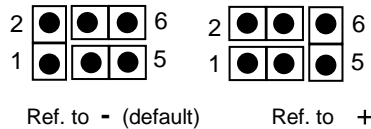

**4÷20mA signal operating mode configuration:**

To set the operating mode of the 4...20mA signal, it is necessary to use the 5<sup>th</sup> selector of the DIP switch at **SW1**; in particular:

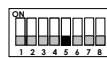

Proportional (4÷20mA)

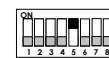

Threshold Logic (0-10-20mA)

**Setting threshold limit values:**

To set the threshold limit values of the optional relay card, or of the threshold operating mode of the 4...20mA signal, it is necessary to use the last selector of the DIP switch at **S1** (ignore the first four selectors (\*)); in particular, the thresholds, given in percentage Full-Scale, will be:

(\* When the first four dip-switch selectors are in the OFF position, the intervention thresholds can only be set by means of the service and maintenance terminal **TUS40 ..** or through the Display (DR... or DN... board).

If this selection is made without the presence of the service terminal, the device will assume the default thresholds as intervention thresholds.

For the use of the terminal see the relevant operating manual.

If the DR- or DN- Display Board is present, the **TUS40 ..** terminal can no longer be used.

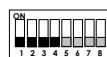

CUSTOM (\*)

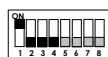

3, 5, 10%

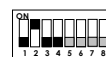

5, 10, 15%

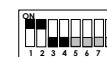

5, 10, 20%



10, 15, 25%

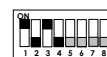

10, 15, 30%



10, 20, 40% (DEFAULT)

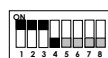

10, 25, 35%



15, 25, 40%

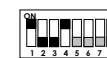

15, 30, 45%

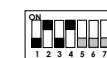

25, 35, 50%

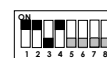

20, 40, 60%

-----Future Implementations-----

**Mechanical installation of the optional Relay Card or optional PhotoMos Cards with resistive output variation**

On the main electronic card, it is possible to insert, in a special connector named **CN1**, a module having on board N. 4 relays with changeover contact that will be activated in correspondence of the pre-alarm events, 1<sup>st</sup> alarm threshold, 2<sup>nd</sup> alarm threshold and faulty sensor, and the relative LEDs signalling.

Follow the steps below to insert the card:

**Phase 1:**

Insert on the main electronic card the card guide supplied with the card, taking care to turn the elastic flag towards the main terminal board.

Locate the connector CN1.

Card Guide (with Elastic Flag)

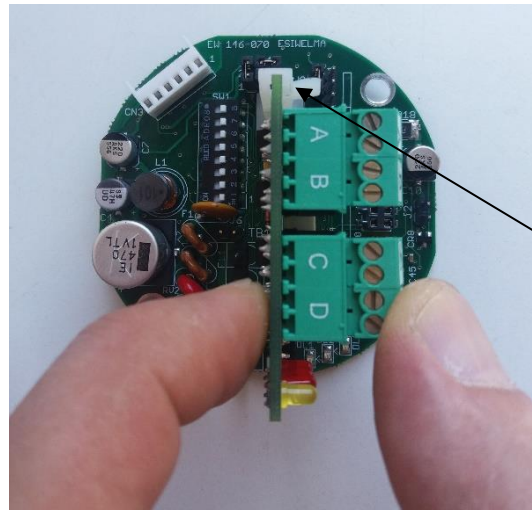
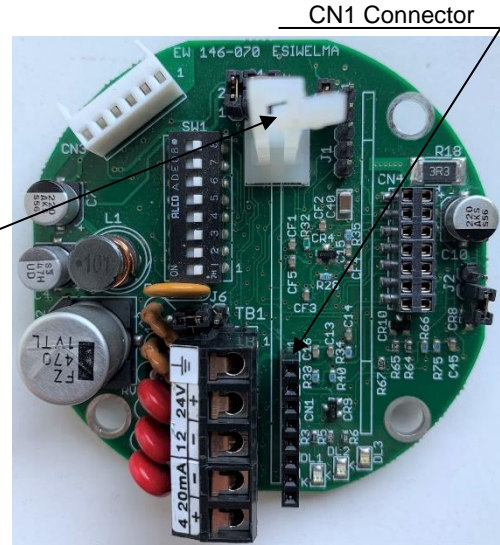

**Phase 2:**

Fully insert the card, taking care to pull the elastic flag of card guide towards the terminal board of the optional card.

Elastic Flag

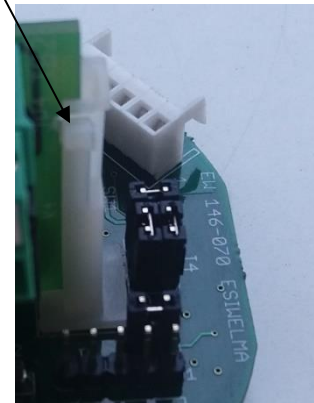

**Phase 3:**

Check the positioning of the card checking that all Pins are internal to the CN1 connector and that, by practicing a slight pull upwards, the card remains in position due to correctly hooked and held by the elastic flag of the card guide.

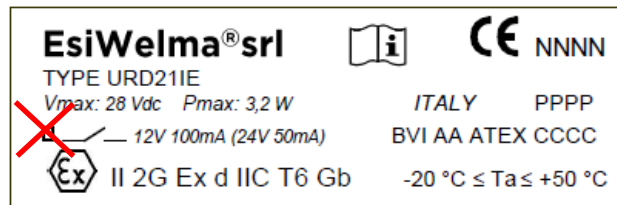

**Phase 4:**

Mark the box showing the presence of the relay card inside the device with a permanent marker (example).



**Electrical installation of the optional relay card**

After the relay card is mechanically installed it is necessary to provide for its electrical configuration by selecting the relay control logic and the type of contact that is required on the terminal board (NC or NO).

**Type of contact selection:**

For each relay there is a pair of removable terminals to which the type of contact (NC or NO) can be associated, selectable by jumpers **JP1...JP4** of the relay card.

- Contact NC or NO of pre-alarm relay
- Contact NC or NO of 1<sup>st</sup> Threshold relay
- Contact NC or NO of 2<sup>nd</sup> Threshold relay
- Contact NC or NO of Fail relay

- DL1 (yellow), Sensor FAULT
- DL2 (red), 1<sup>st</sup> Alarm Threshold
- DL3 (red), 2<sup>nd</sup> Alarm Threshold
- DL4 (red), Pre-alarm

Type of contact selection:

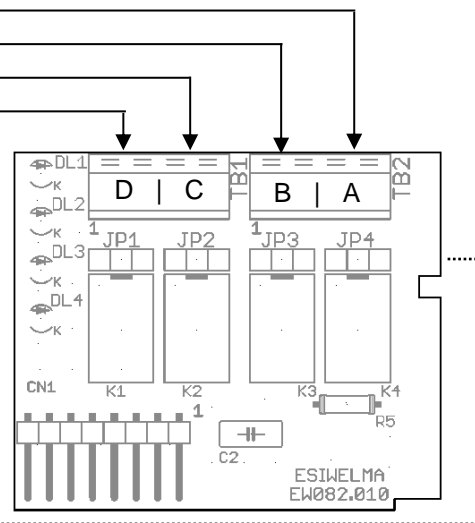
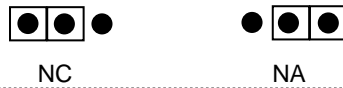

**Setting of relay control logic:**

To perform the setting of the control logic of the direct relays (relay energized in the presence of an event) or reverse (relay energized in the absence of an event), it is necessary to act on the 6<sup>th</sup> dip-switch of the **SW1** selector; in particular:

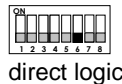

**Preliminary checks after mechanical and electrical installation**

The sensor is calibrated in the factory and therefore there are no calibration operations once installed; however, after installation it is necessary to perform a functional check of the sensors. By powering the device it will prepare itself in the sensor preheating phase which lasts about 2 minutes.

After this time the sensor will pass into normal operating state, however the best performance can be obtained after about 2 hours.

Once the sensor is operational, it is necessary to check its response using the appropriate **TUL40..** test kit consisting of:

- 2 bottles of titrated gas: 1 at 5000ppm of CO<sub>2</sub> and 1 of pure nitrogen (see ordering codes of the test kit on the specific data sheet)
- specific pressure reducer and flow regulator **TUL40.FLUX** or equivalent, in order to guarantee a flow of about 0.5 liters / minute;
- universal adapter to adapt to the sensor body (**URCAP.ESI**);
- connecting pipe between the cylinder and the adapter, approximately 2m long.

During the test it is necessary to observe the value of the output current, the status of the LED visible outside the container on the sensor body and, if present, the status of the relay board LEDs, before closing the case.

The LED on the sensor body and the 4 ... 20mA output have the following functional meaning:

Sensor State	4÷20mA Output	State Led on Sensor Body
PREHEATING	2mA	Flashing with 2 Hz frequency
WORKING	4÷20mA	1 pulse "ON" every about 10s
PRE-ALARM	0, 10, 20mA for threshold applications	2 pulses "ON" every about 5s
1 <sup>st</sup> ALARM THRESHOLD		3 pulses "ON" every about 5s
2 <sup>nd</sup> ALARM THRESHOLD		4 pulses "ON" every about 5s
FAILED SENSOR	22mA	ON steady
OVER-RANGE FAILURE	22mA	1 pulse "OFF" every about 5s

Once the **5000ppm CO<sub>2</sub>** mixture is applied using the test kit (*test gas application time > 2 minutes*), make sure that the 4 ÷ 20mA output is between 7 and 9mA; the status LED and the pre-alarm, 1st and 2nd alarm threshold on the optional relay card switch on according to the threshold settings.

Use the pure nitrogen bottle for zero calibration / verification.

## Troubleshooting

For Troubleshooting, having only one LED that identifies the functional states described in the table above, when operating failure occur, in addition to the usual power and wiring checks, it is necessary to use the *TUS40* terminal or use the *Display Board* (if present) and refer to the relevant product documentation (see also Notes 2 and 3 in technical features for **Over-Range Failure**).

## Maintenance

Every three to six months a functional check of the sensors must be carried out, in accordance with the instructions contained in Standard EN60079-29-2.

### Routine

The routine check involves the performance of the same tests as described in the chapter concerning preliminary checks after mechanical and electrical installation.

### Corrective

Any failure found during the periodic checks of the sensors must be followed by sending the sensor to your Supplier / Installer, who will send it to EsiWelma.

Possible sensors non-calibration found during the periodic checks can be identified and corrected with the help of the **TUL40..** test kit .. and the **TUS40..** service terminal, (or of the display board) which must be connected to the sensor (on the **CN3** connector) through the appropriate communication interface integrated in the cable.

For the sensor recalibration procedure, refer to the documentation supplied with the service terminal, the display board or the card for the magnetic actuator.

## Disassembly

Power off the detector, disconnect the wire on the terminals and dismount the housing from any blocking system.

## Warranty

Warranty of the products is indicated in the General Sale Conditions to which reference is made.

## Accessories and Spare Parts

- Relay Card with n. 4 SPDT relay **UZR20.4**
- Display Board with Relay **DR** (Det.Name)
- Display Board without Relay **DN** (Det.Name)
- PhotoMOS Card **UZS20..**
- Magnetic Actuator Card **UZMAG**
- Magnetic Actuator **UCM**
- Test Kit **TUL40..**
- Service Terminal Kit **TUS40..**
- Sensor Body **NRXX-Y-ZZZ**

## Dimensions and Weight

Dimensions (HxWxD): 164x100x82mm.

Weight: 0,8Kg

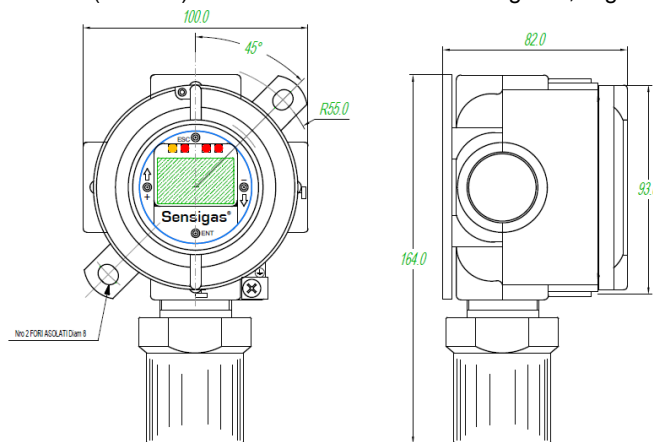

## Legend of Marking



Marking in compliance with all applicable Directives

1370

Identification number of the Notified Body for manufacturing survey



Marking for all equipment in conformity to ATEX 2014/34/EU Directive

II Equipment Group for surface industry

2 Equipment Category 2 for use in Zone 1

G Equipment intended for use in explosive gas atmosphere, caused by mixture of air and gas, vapours, flammable mists.

Ex d IIC T6<sup>(1)</sup> Gb Type of protection according to EN60079-0, EN60079-1 and EN60079-29-1

BVI 07 ATEX 0032 EC Type Examination Certificate and possible extensions

-20°C ≤ TA ≤ +50°C Environmental temperature range of the appliance (Standard)

-40°C ≤ TA ≤ +70°C Extended temperature range of the appliance (Extended)

Note <sup>(1)</sup>: DR-URD21IE-EXR detectors, i.e. equipped with Display Board with Relay (prefix **DR-**), with extended temperature range (suffix **-EXR**), have temperature class T5 instead of T6.

Due to our policy of continuous product improvement, specifications are subject to change without notice.

<b>EsiWelma® srl</b>	EW146.6D1_en - rev. B	Carbon Dioxide Detectors – URD21IE
27/04/21	Gas detection systems for ind. environments	8/8